

45816

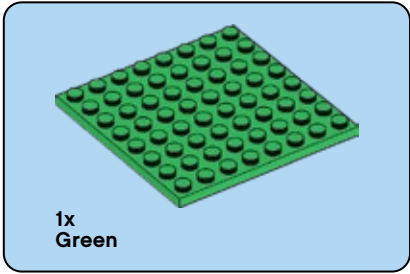

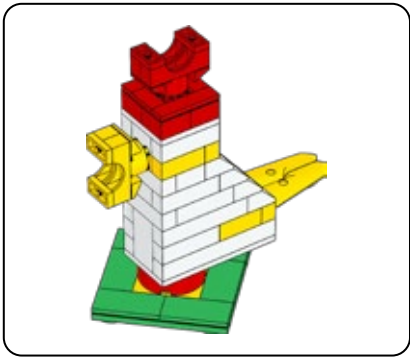

1

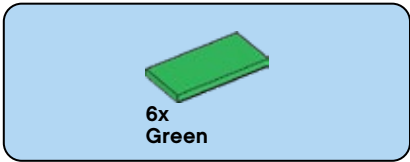

2

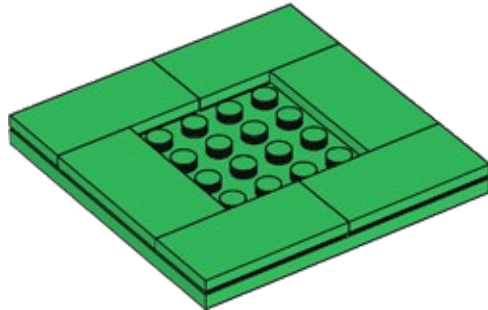
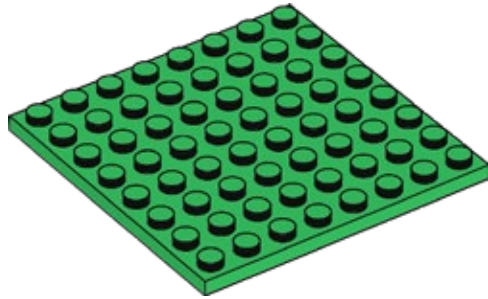

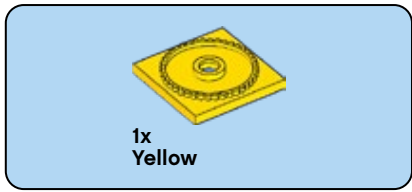

3



4

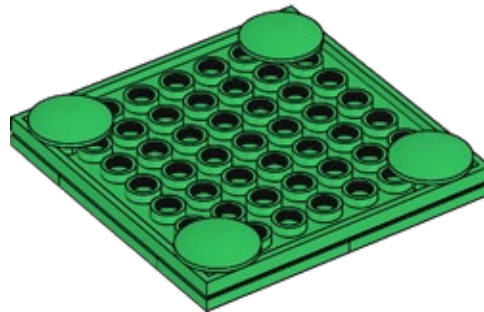
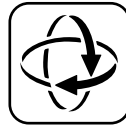

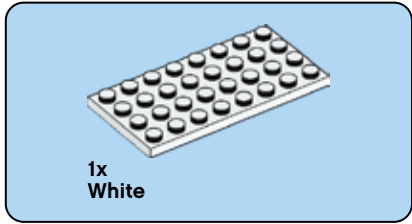
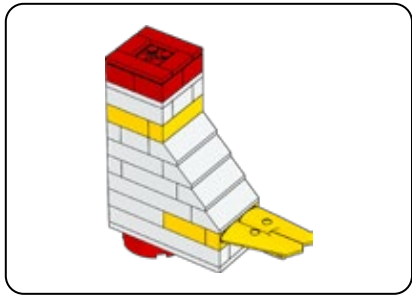

5

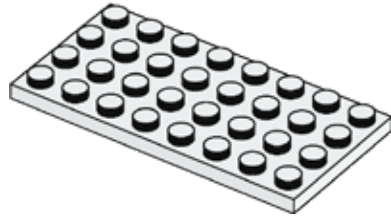

6

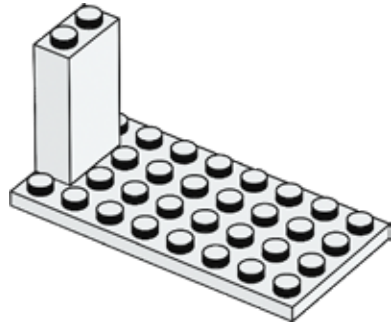

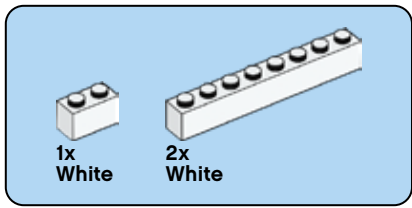

7

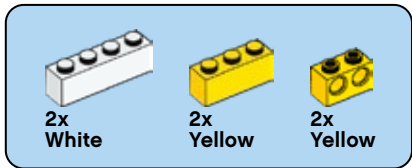
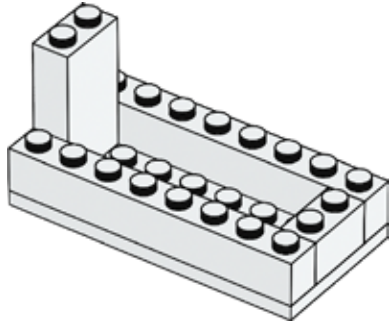

8

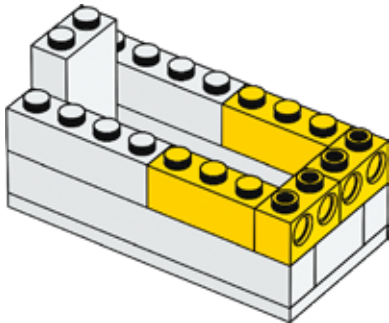

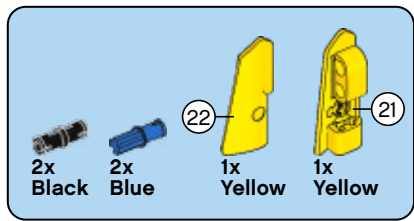

9

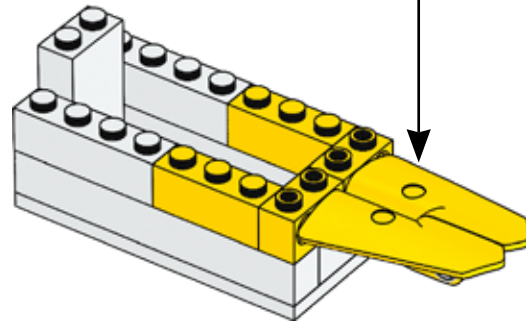
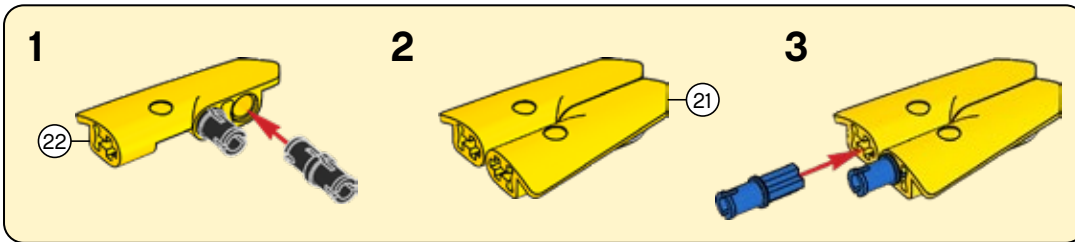

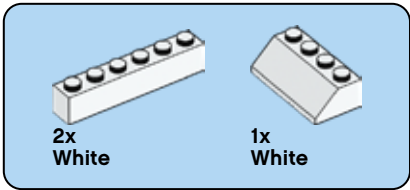

10

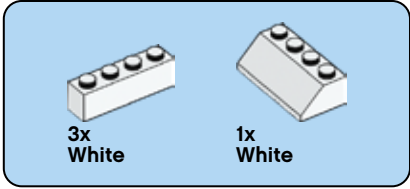
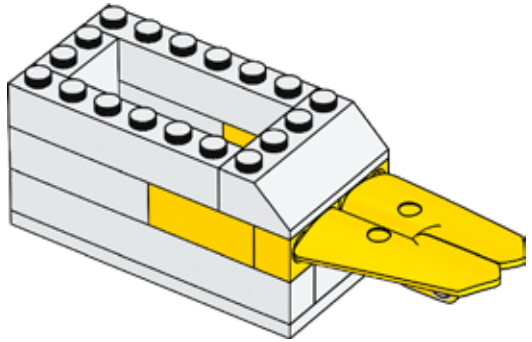

11

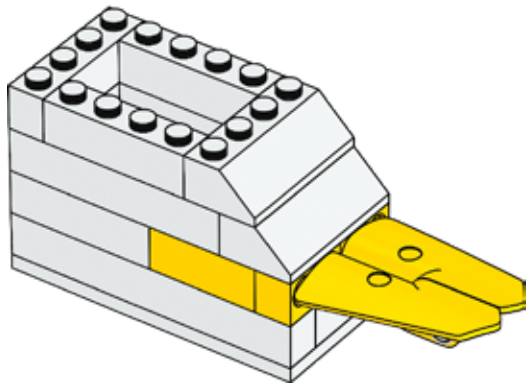

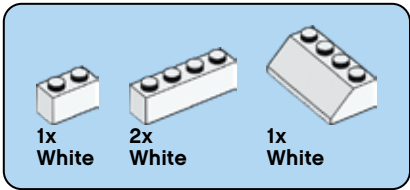

12

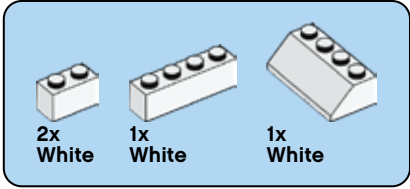
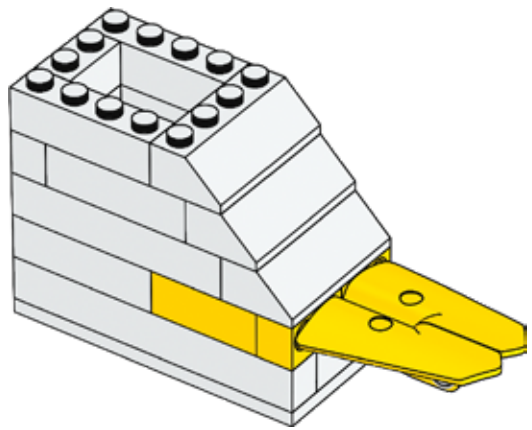

13

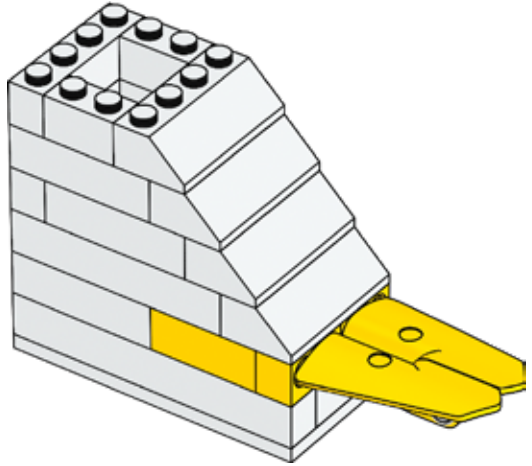



1x
Yellow

14

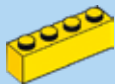
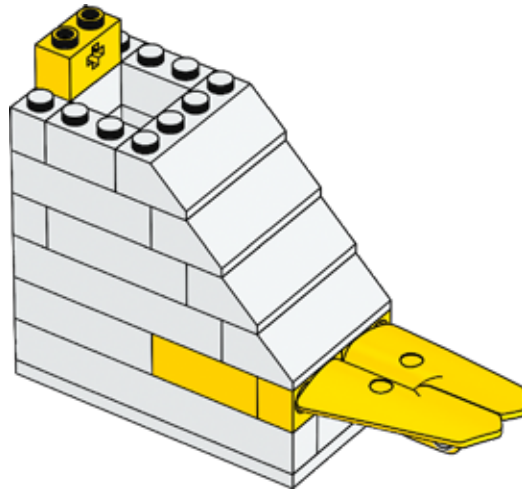

1x
Yellow



2x
Yellow

15

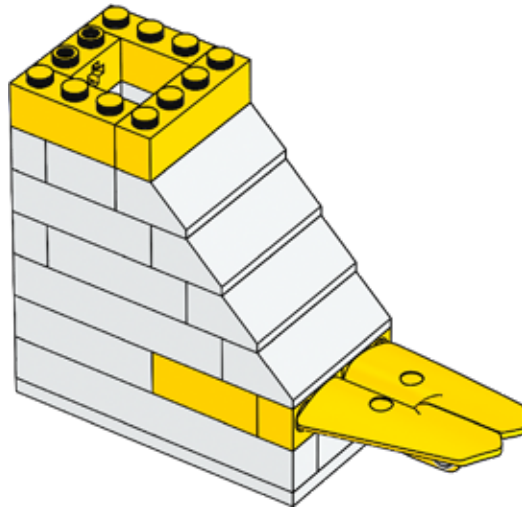

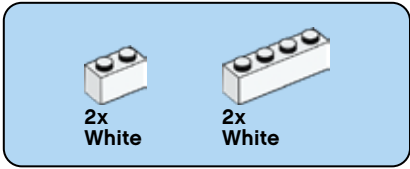

16

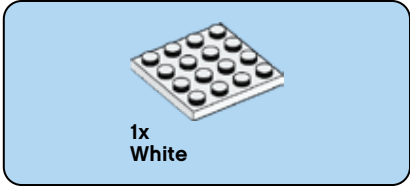
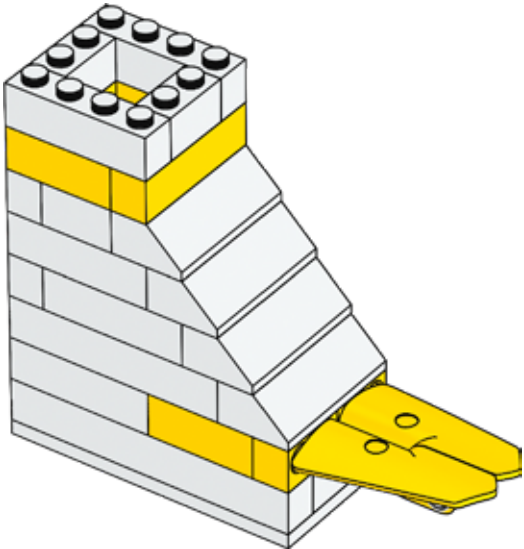

17

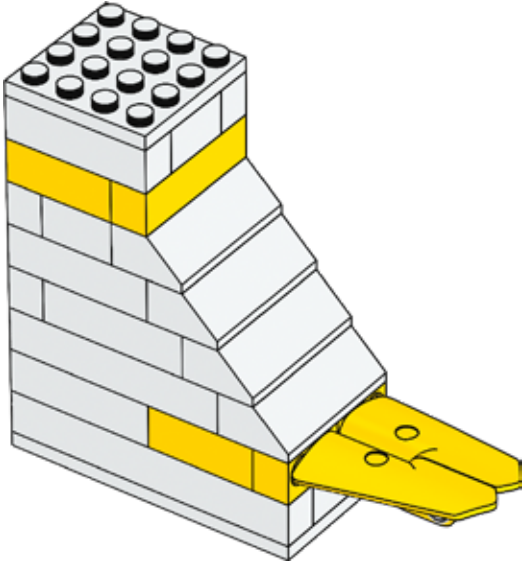



1x
Red

18

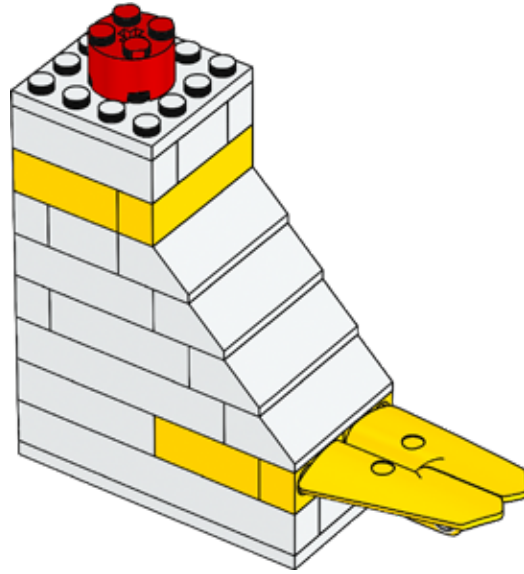

5



4x
Red

19

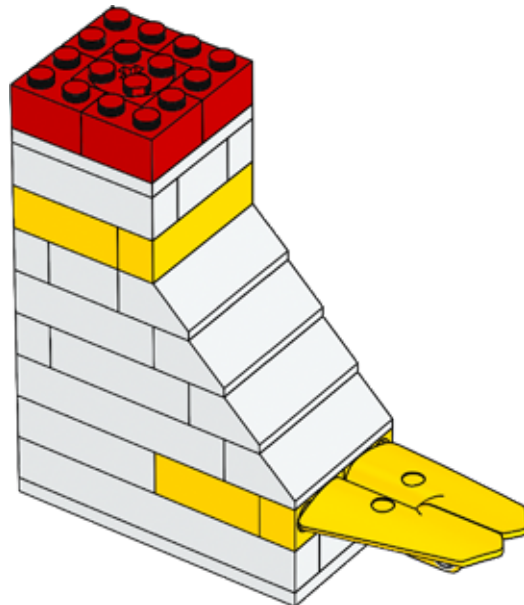

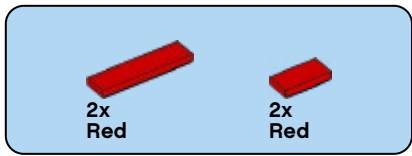

20

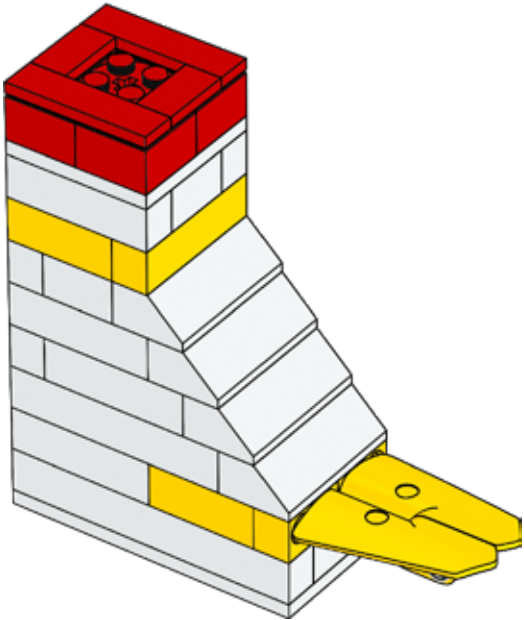



21

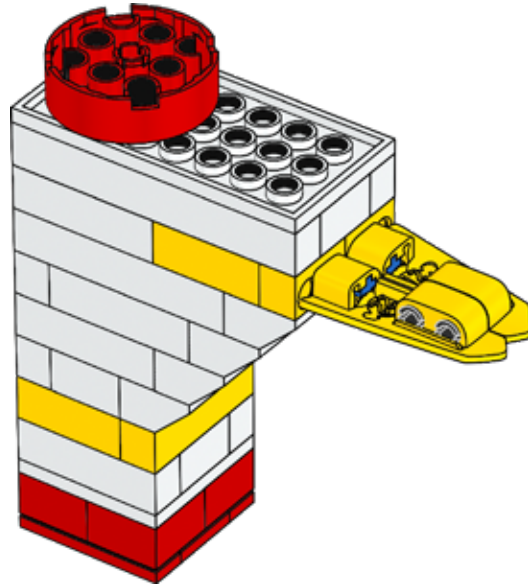
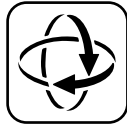

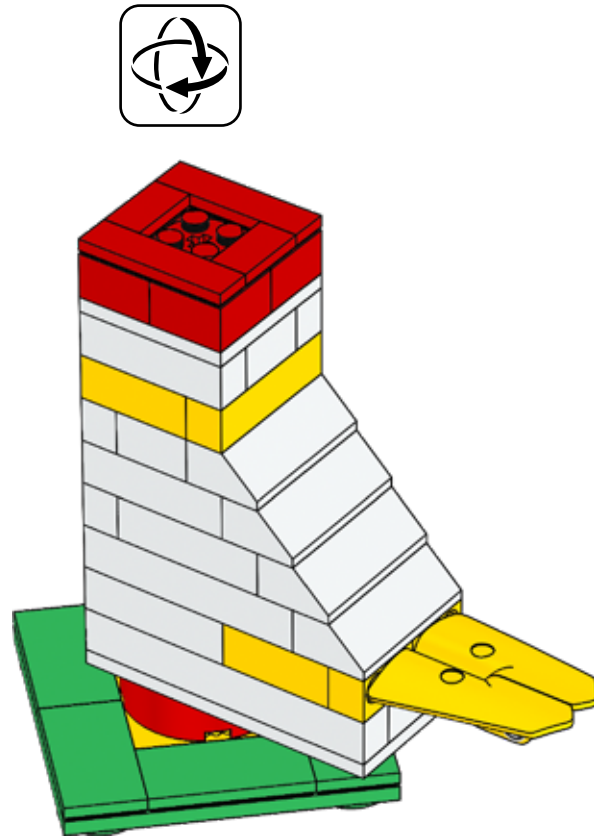

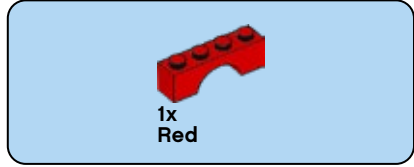
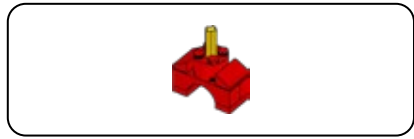

23

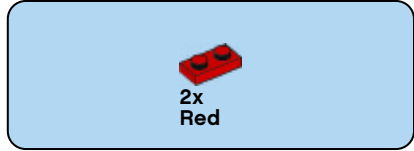
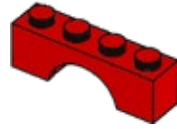

24

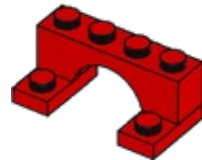

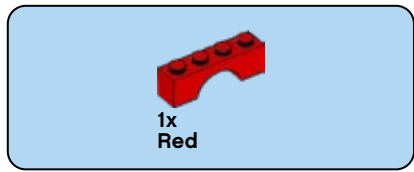

25

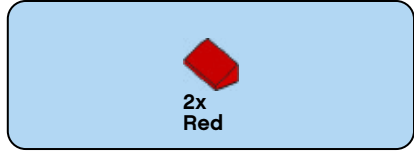
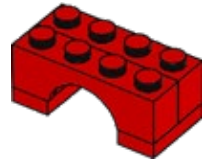

26

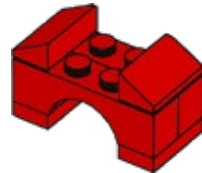



1x
Red

27

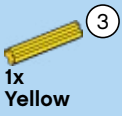
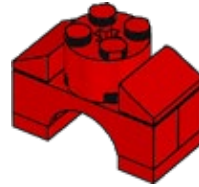

1x
Yellow

28

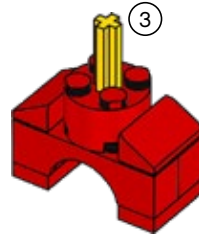

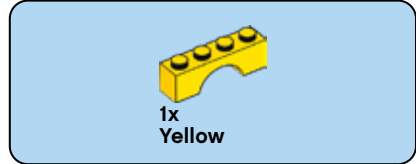
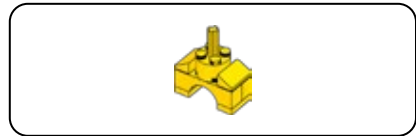

30

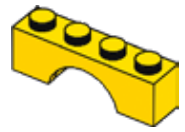

31

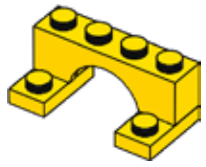

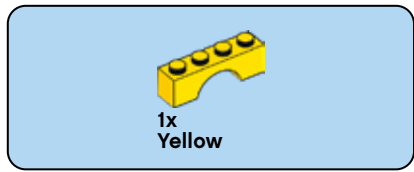

32

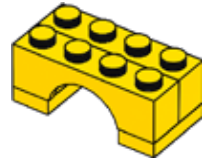

33

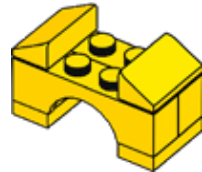



1x
Yellow

34

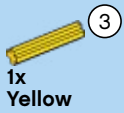
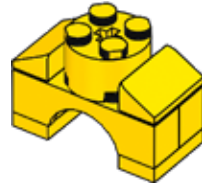

1x
Yellow

35

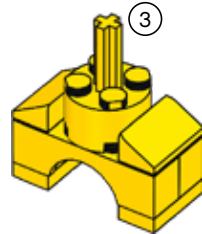

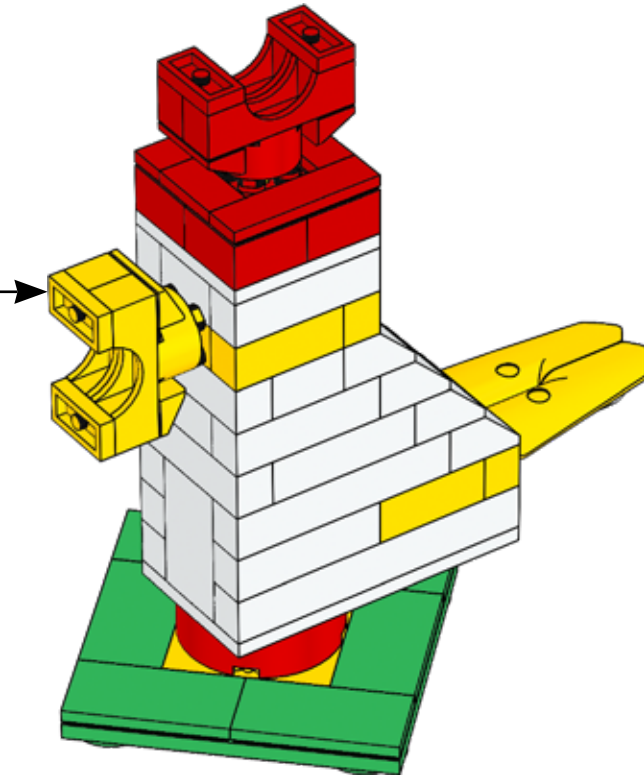

LEGO and the LEGO logo are trademarks of the/son des marques de commerce du/son marcas registradas de LEGO Group. ©2021 The LEGO Group. All rights reserved/Tous droits réservés/Todos los derechos reservados.

FIRST® is a registered trademark of For Inspiration and Recognition of Science and Technology (FIRST). LEGO® is a registered trademark of the LEGO Group. FIRST® LEGO® League and CARGO CONNECT™ are jointly held trademarks of FIRST and the LEGO Group.

©2021 FIRST and the LEGO Group. All rights reserved.